

Nov. 19, 1968

J. A. ROLL ET AL

3,411,591

COIL POWER SPRING IMPACT MECHANISM

Filed March 3, 1966

28 Sheets-Sheet 1

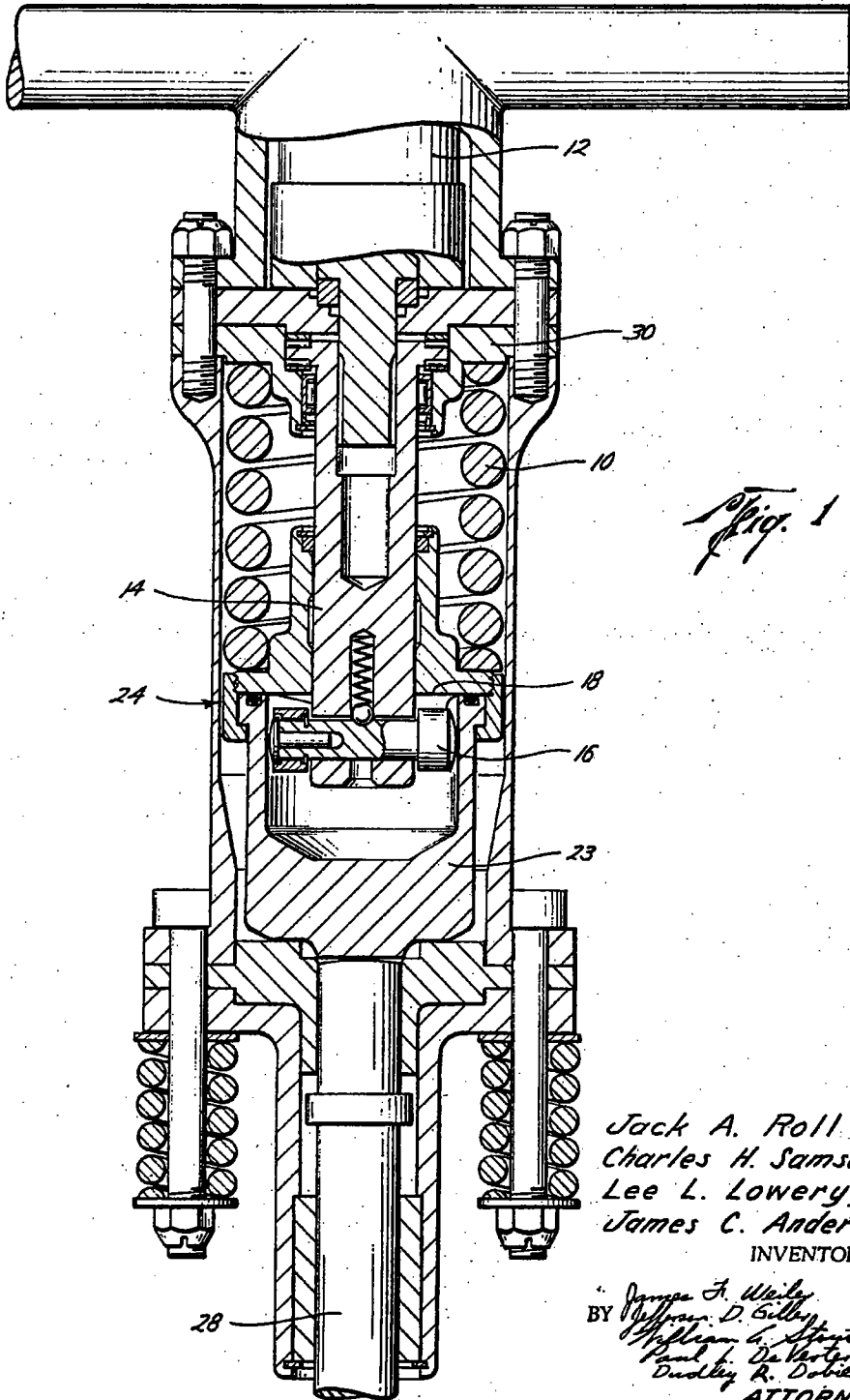

*Fig. 1*

Jack A. Roll  
Charles H. Samson, Jr.  
Lee L. Lowery, Jr.  
James C. Anderson  
INVENTORS

BY *James F. Wiley*  
*William D. Gilling*  
*William C. Spont*  
*Paul F. DeWitt, Jr.*  
*Dudley R. Doherty, Jr.*  
ATTORNEYS

Nov. 19, 1968

J. A. ROLL ET AL

3,411,591

COIL POWER SPRING IMPACT MECHANISM

Filed March 5, 1966

28 Sheets-Sheet 2

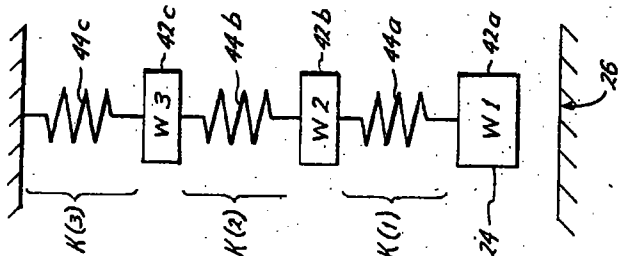

*Fig. 6*

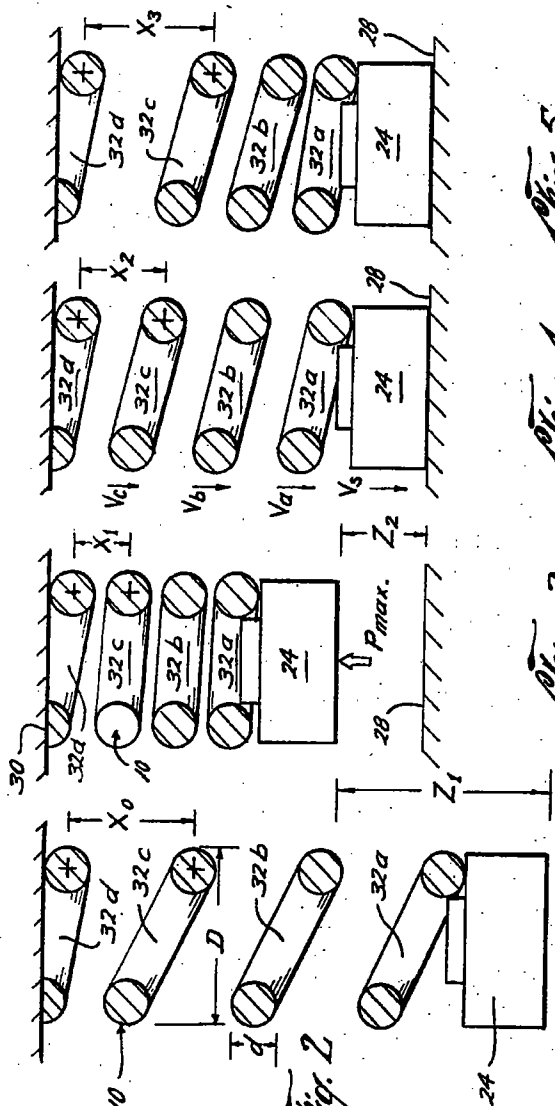

*Fig. 5*

*Fig. 4*

*Fig. 3*

*Fig. 2*

Jack A. Roll  
 Charles H. Samson, Jr.  
 Lee L. Lowery, Jr.  
 James C. Anderson

INVENTORS

BY *James F. Wicks*  
*Jefferson D. Gilley*  
*William C. Stewart*  
*Paul H. DeWester II*  
*Dudley R. Dobie Jr.*  
 ATTORNEYS

Nov. 19, 1968

J. A. ROLL ET AL

3,411,591

COIL POWER SPRING IMPACT MECHANISM

Filed March 3, 1966

28 Sheets-Sheet 3

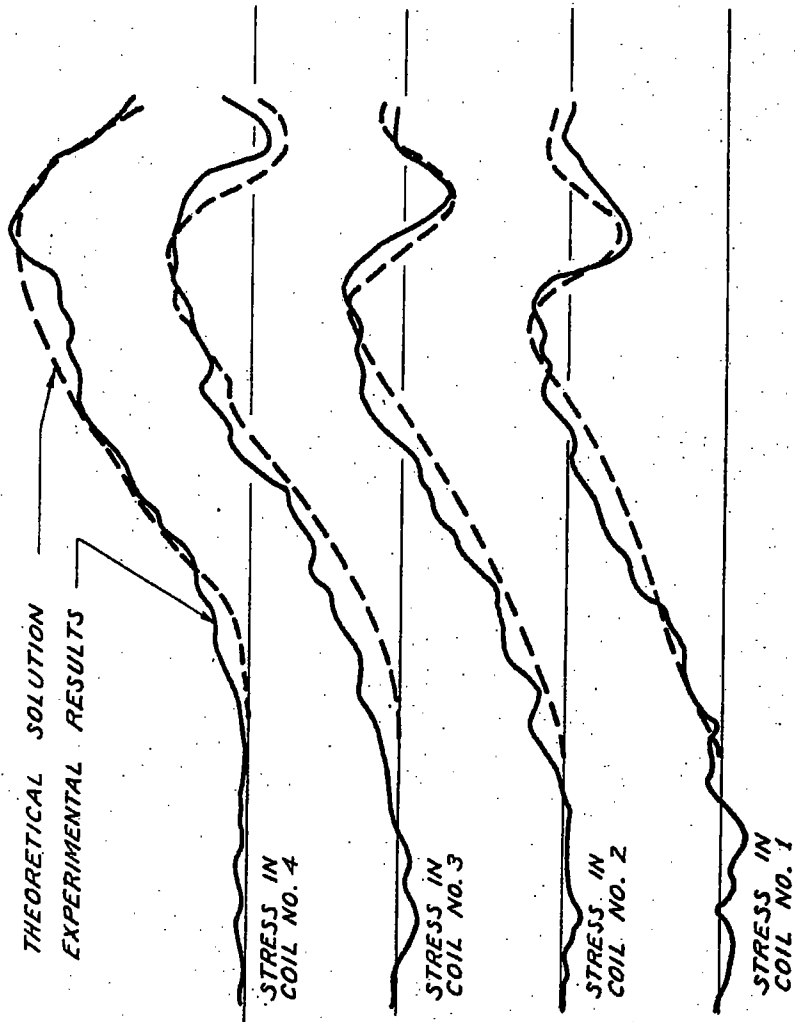

*Fig. 7*

Jack A. Roll  
Charles H. Samson, Jr.  
Lee L. Lowery, Jr.  
James C. Anderson

INVENTORS

BY *James F. Heiber*  
*Jefferson D. Gilber*  
*William C. Gilbert*  
*Paul F. De Vante, III*  
*Dudley R. De Vante, Jr.*  
ATTORNEYS

Nov. 19, 1968

J. A. ROLL ET AL

3,411,591

COIL POWER SPRING IMPACT MECHANISM

Filed March 3, 1966

28 Sheets-Sheet 4

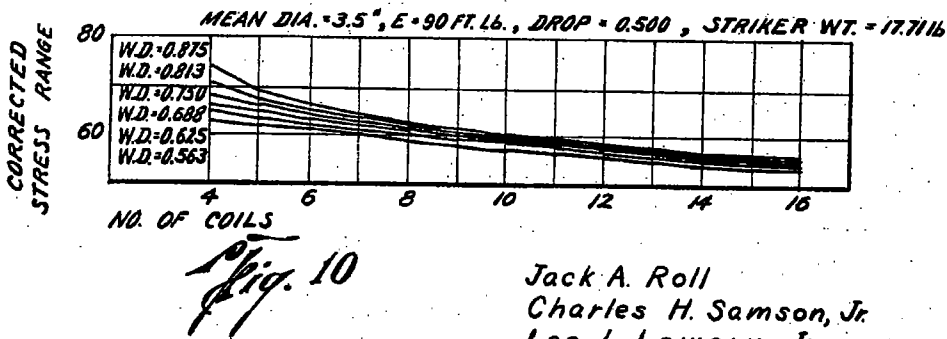
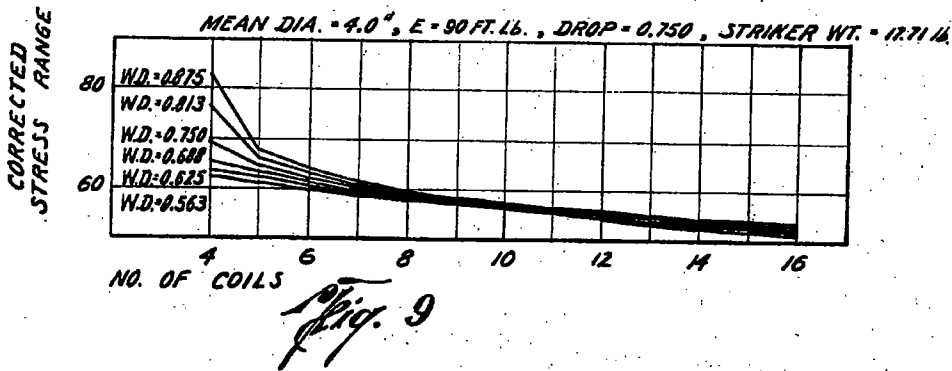
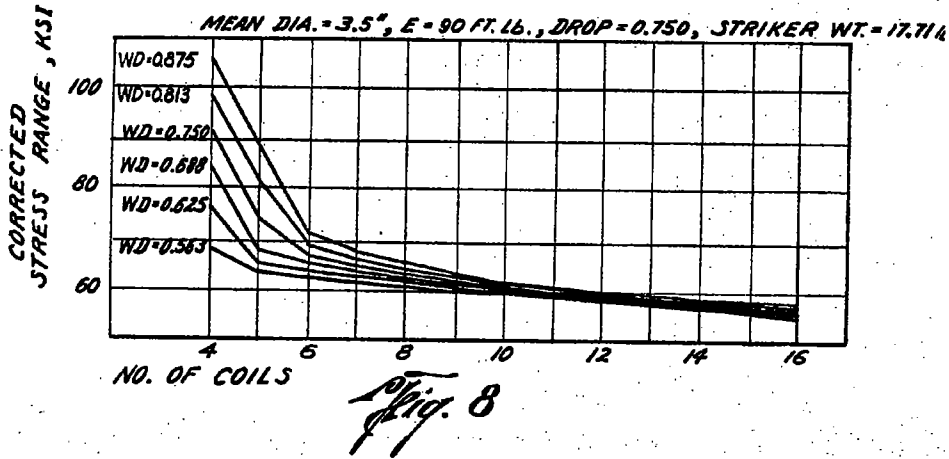

Jack A. Roll  
 Charles H. Samson, Jr.  
 Lee L. Lowery, Jr.  
 James C. Anderson  
 INVENTORS

BY *James F. Miller*  
*Jefferson D. Giffis*  
*William C. Hunt*  
*Paul J. De Vostert*  
*Dudley R. Davis Jr.*  
 ATTORNEYS

Nov. 19, 1968

J. A. ROLL ET AL

3,411,591

COIL POWER SPRING IMPACT MECHANISM

Filed March 3, 1966

28 Sheets-Sheet 5

*Fig. 14*

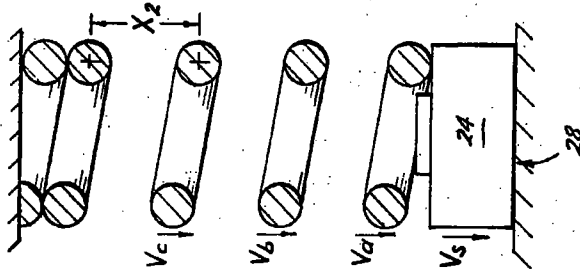

*Fig. 13*

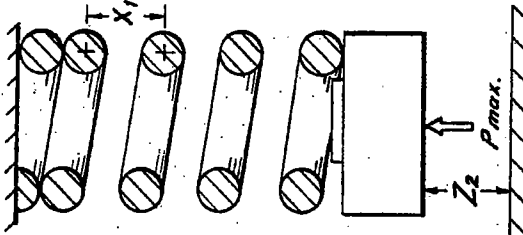

*Fig. 12*

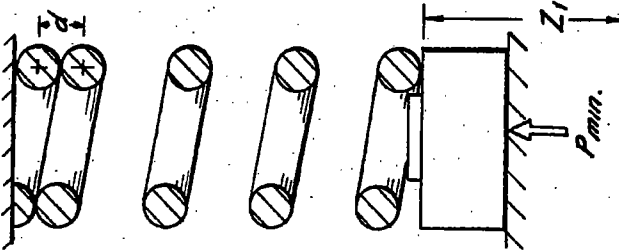

*Fig. 11*

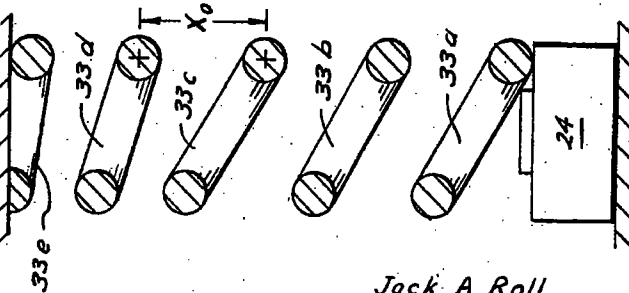

Jack A. Roll  
 Charles H. Samson, Jr.  
 Lee L. Lowery, Jr.  
 James C. Anderson

INVENTORS

BY *James F. Hunter*  
*Jefferson D. Gillet*  
*William R. Street*  
*Paul T. De Venter*  
*Dudley A. Dobie, Jr.*  
 ATTORNEYS

Nov. 19, 1968

J. A. ROLL ET AL

3,411,591

COIL POWER SPRING IMPACT MECHANISM

Filed March 3, 1966

28 Sheets-Sheet 6

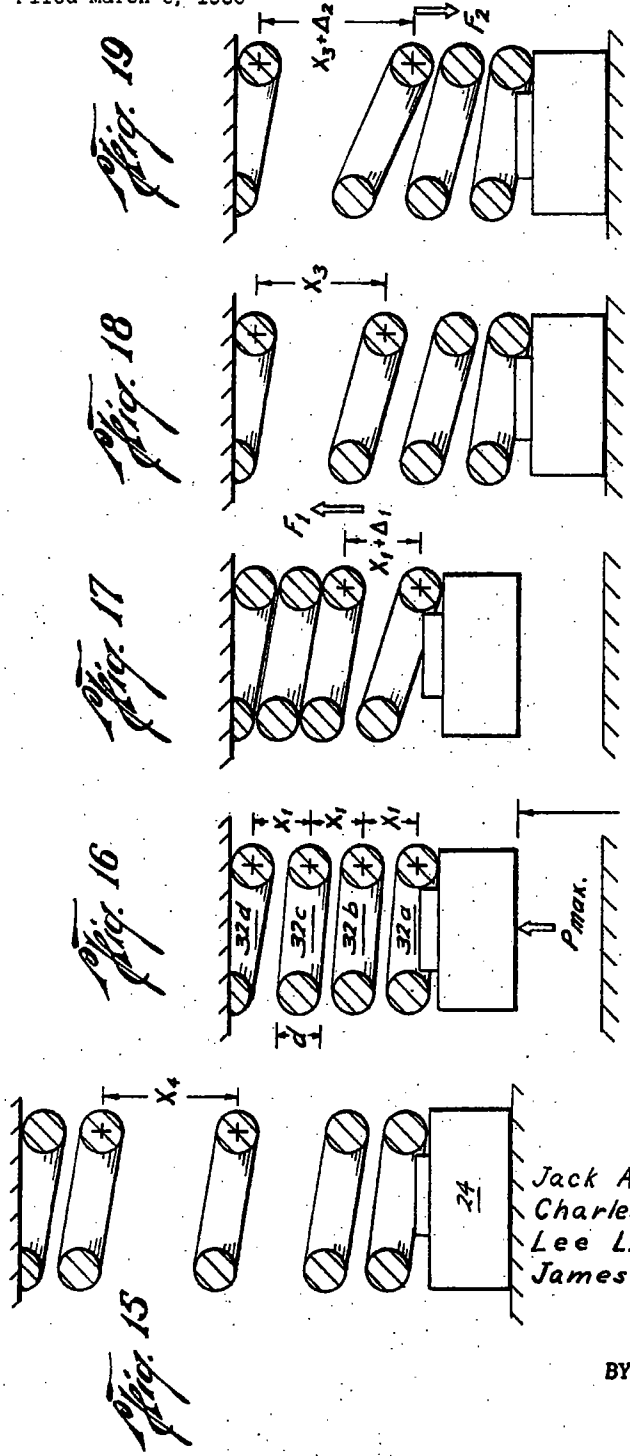

Jack A. Roll  
 Charles H. Samson, Jr.  
 Lee L. Lowery, Jr.  
 James C. Anderson

INVENTORS

BY *James F. Weiler*  
*Jefferson D. Gilley*  
*William G. Stant*  
*Paul J. De Venter, Jr.*  
*Dwight R. Deibel, Jr.*  
 ATTORNEYS

Nov. 19, 1968

J. A. ROLL ET AL

3,411,591

COIL POWER SPRING IMPACT MECHANISM

Filed March 3, 1966

28 Sheets-Sheet 7

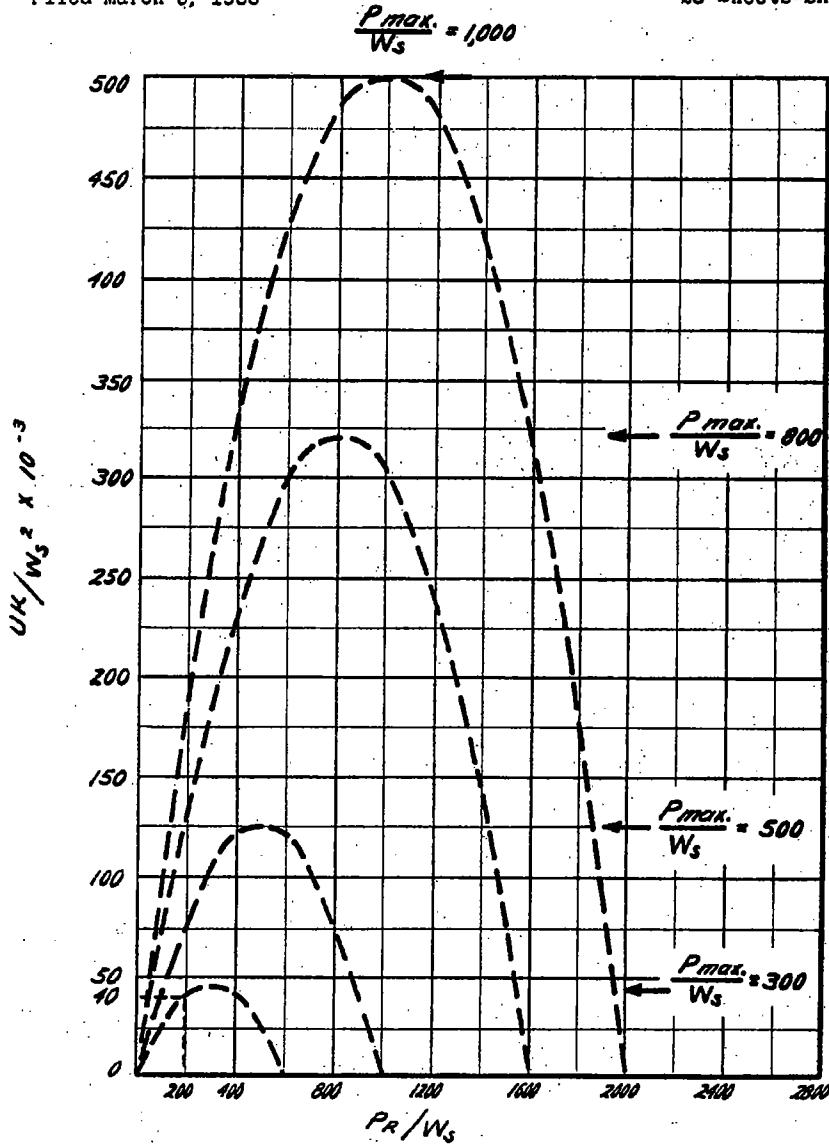

*Fig. 20*

Jack A. Roll  
Charles H. Samson, Jr.  
Lee L. Lowery, Jr.  
James C. Anderson

INVENTORS

BY *James F. Weston*  
*William D. Geller*  
*William G. Stout*  
*Paul I. DeLortz*  
*Dwight A. Debie Jr.*  
ATTORNEYS

Nov. 19, 1968

J. A. ROLL ET AL

3,411,591

COIL POWER SPRING IMPACT MECHANISM

Filed March 3, 1966

28 Sheets-Sheet 8

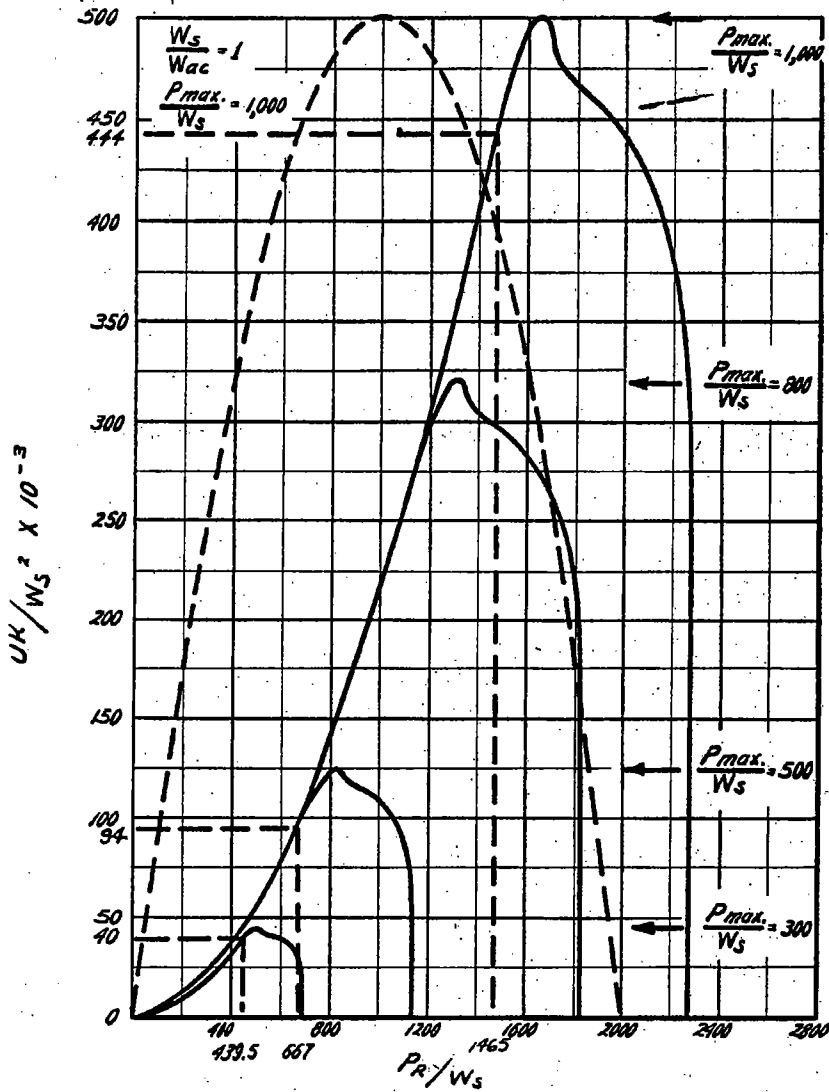

*Fig. 21*

Jack A. Roll  
Charles H. Samson, Jr.  
Lee L. Lowery, Jr.  
James C. Anderson

INVENTORS

BY *James F. Walker*  
*William D. Gilpin*  
*William G. Stout*  
*Paul L. DeWitt*  
*Dudley R. Dobiefr.*  
ATTORNEYS

Nov. 19, 1968

J. A. ROLL ET AL

3,411,591

COIL POWER SPRING IMPACT MECHANISM

Filed March 3, 1966

28 Sheets-Sheet 9

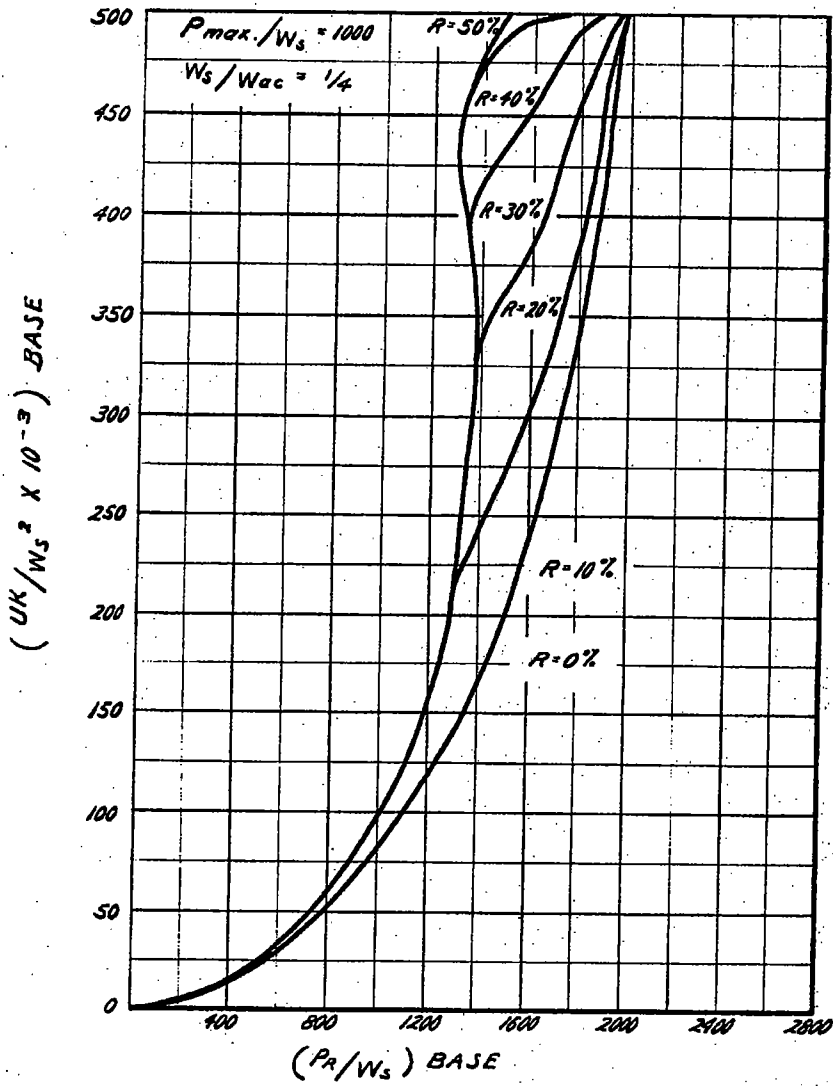

*Fig. 22*

Jack A. Roll  
Charles H. Samson, Jr.  
Lee L. Lowery, Jr.  
James C. Anderson

INVENTORS

BY *James J. White*  
*Jefferson D. Gilpin*  
*William A. Hunt*  
*Paul L. DeWester, Jr.*  
*Dudley R. Tobie, Jr.*  
ATTORNEYS

Nov. 19, 1968

J. A. ROLL ET AL

3,411,591

COIL POWER SPRING IMPACT MECHANISM

Filed March 3, 1966

28 Sheets-Sheet 10

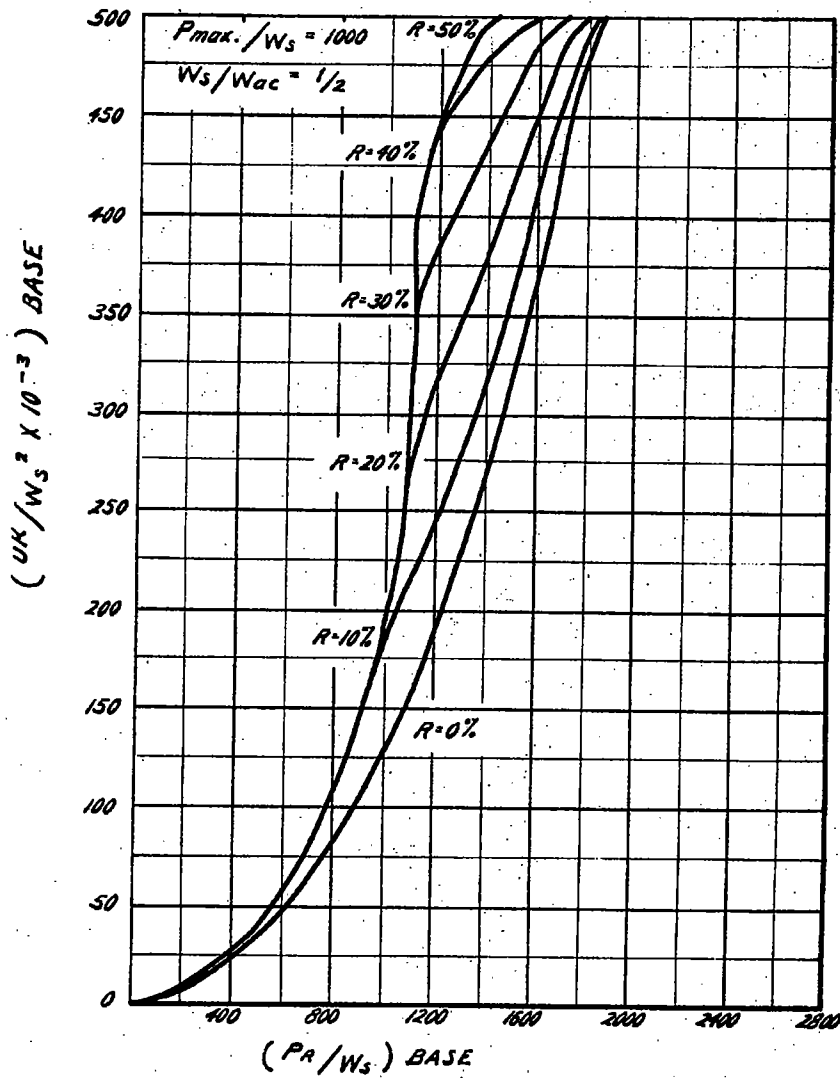

*Fig. 23*

Jack A. Roll  
Charles H. Samson, Jr.  
Lee L. Lowery, Jr.  
James C. Anderson

INVENTORS

BY *James F. Uebler*  
*William D. Gillis*  
*William G. Stout*  
*Paul L. DeVoster, Jr.*  
*Dudley R. Dobie, Jr.*  
ATTORNEYS

Nov. 19, 1968

J. A. ROLL ET AL

3,411,591

COIL POWER SPRING IMPACT MECHANISM

Filed March 3, 1966

28 Sheets-Sheet 11

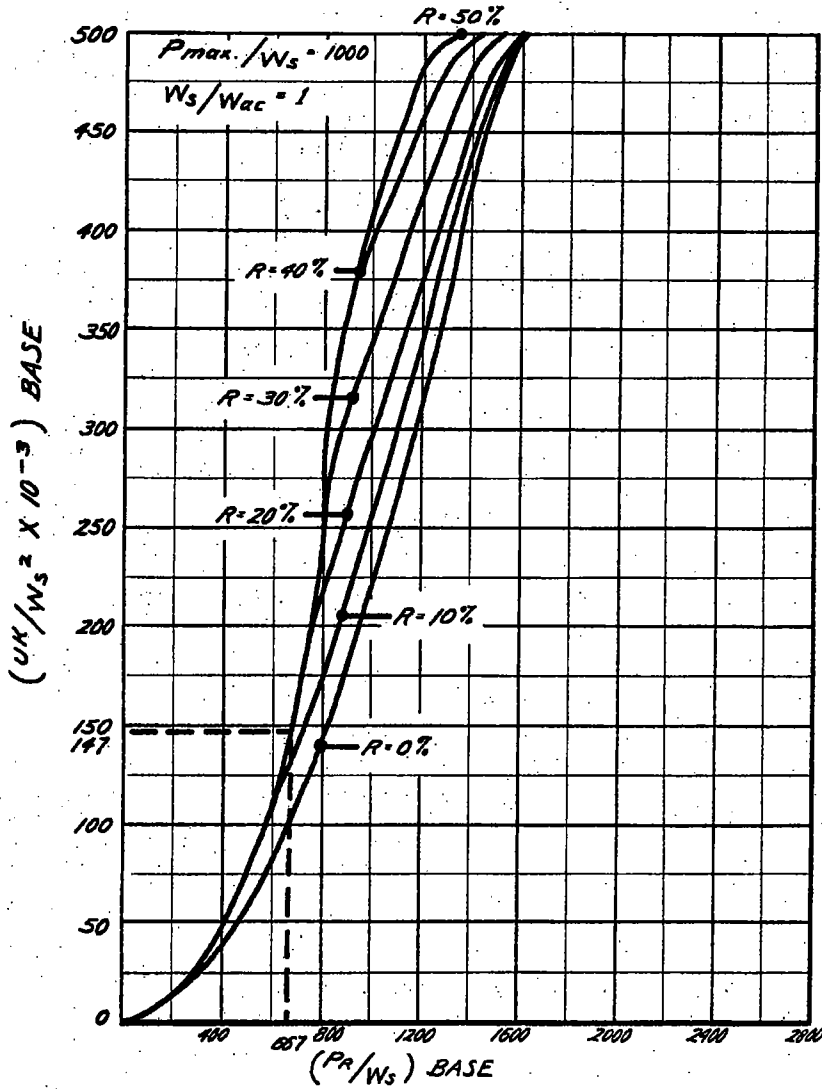

*Fig. 2A*

Jack A. Roll  
Charles H. Samson, Jr.  
Lee L. Lowery, Jr.  
James C. Anderson

INVENTORS

BY *James F. Wiley*  
*William D. Gilley*  
*William G. Stout*  
*Paul J. De Voster, III*  
*Dudley R. Daboe, Jr.*  
ATTORNEYS

Nov. 19, 1968

J. A. ROLL ET AL

3,411,591

COIL POWER SPRING IMPACT MECHANISM

Filed March 3, 1966

28 Sheets-Sheet 12

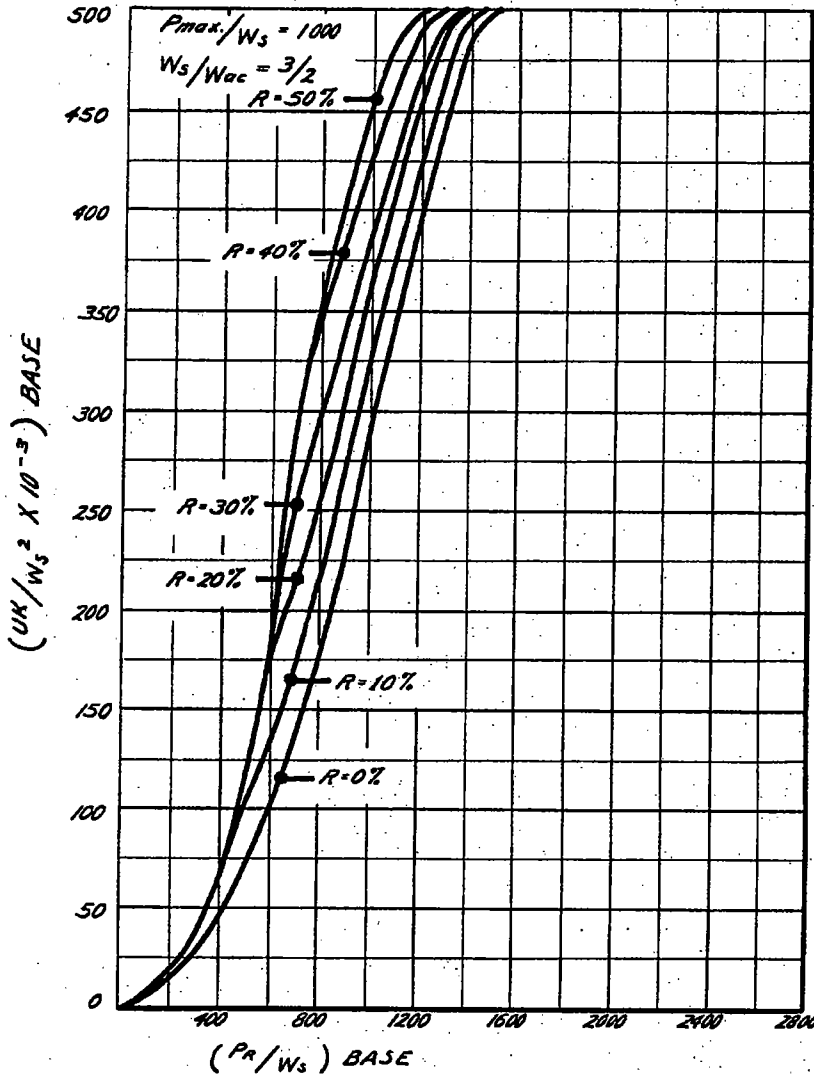

*Fig. 25*

Jack A. Roll  
Charles H. Samson, Jr.  
Lee L. Lowery, Jr.  
James C. Anderson

INVENTORS

BY *James A. Wailer*  
*Jefferson D. Giffen*  
*William A. Stout*  
*Paul L. DeVetter, Jr.*  
*Dudley R. Dobie, Jr.*  
ATTORNEYS

Nov. 19, 1968

J. A. ROLL ET AL

3,411,591

COIL POWER SPRING IMPACT MECHANISM

Filed March 3, 1966

28 Sheets-Sheet 13

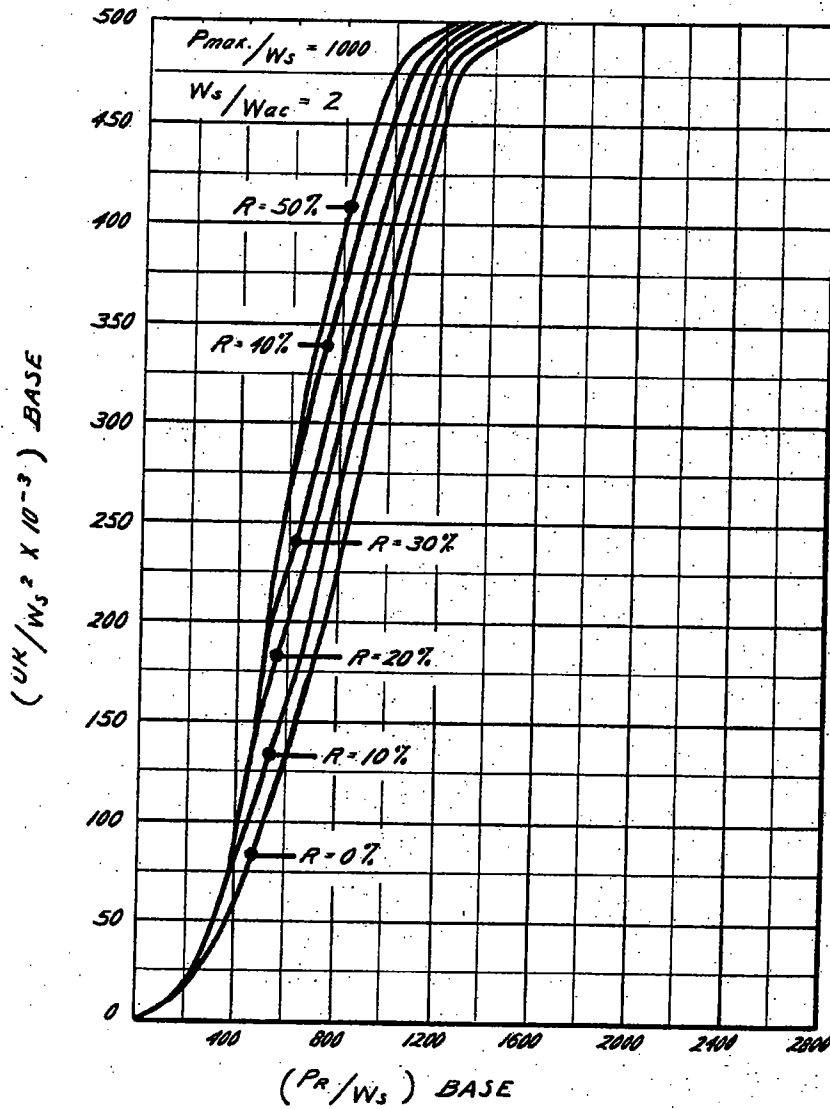

*Fig. 26*

Jack A. Roll  
Charles H. Samson, Jr.  
Lee L. Lowery, Jr.  
James C. Anderson

INVENTORS

BY *James F. Weiler*  
*Jefferson D. Gifford*  
*William C. Stout*  
*Paul L. Doobler II*  
*Dudley R. Dobie Jr.*  
ATTORNEYS

Nov. 19, 1968

J. A. ROLL ET AL

3,411,591

COIL POWER SPRING IMPACT MECHANISM

Filed March 3, 1966

28 Sheets-Sheet 14

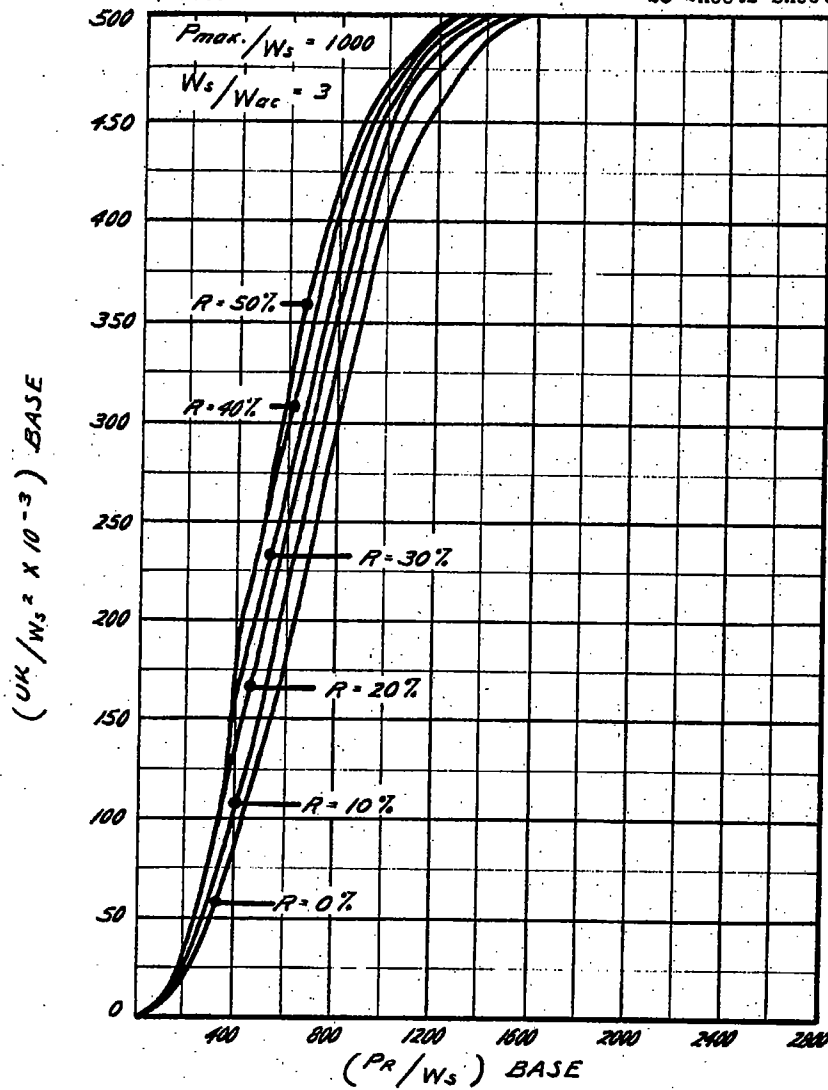

*Fig. 27*

Jack A. Roll  
Charles H. Samson, Jr.  
Lee L. Lowery, Jr.  
James C. Anderson

INVENTORS

BY *James F. Shaker*  
*William D. Giffey*  
*William C. J. Jansit*  
*Paul J. DeKortor II*  
*Dudley R. Debie Jr.*  
ATTORNEYS

Nov. 19, 1968

J. A. ROLL ET AL

3,411,591

COIL POWER SPRING IMPACT MECHANISM

Filed March 3, 1966

28 Sheets-Sheet 15

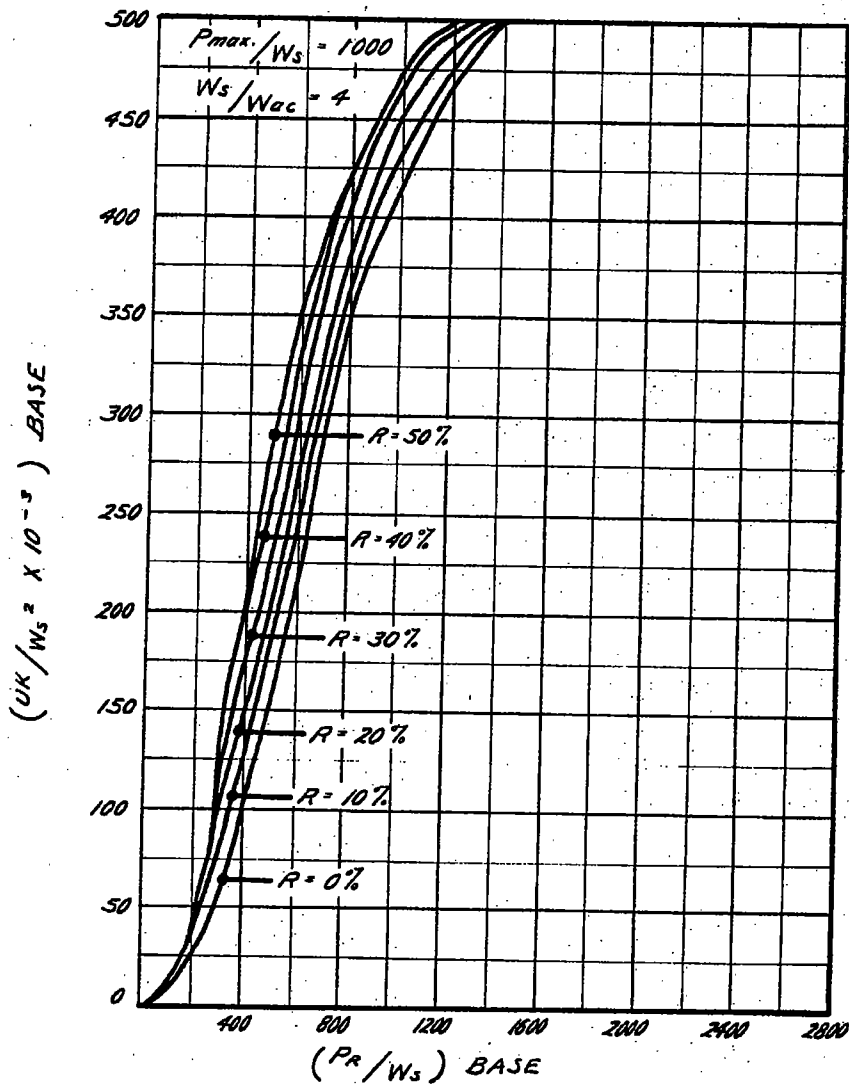

*Fig. 28*

Jack A. Roll  
Charles H. Samson, Jr.  
Lee L. Lowery, Jr.  
James C. Anderson

INVENTORS

BY *James F. Weiler*  
*Jefferson D. Gilley*  
*William C. Hunt*  
*Paul L. DeWester II*  
*Dudley R. Dobie Jr.*  
ATTORNEYS

Nov. 19, 1968

J. A. ROLL ET AL

3,411,591

COIL POWER SPRING IMPACT MECHANISM

Filed March 3, 1966

28 Sheets-Sheet 16

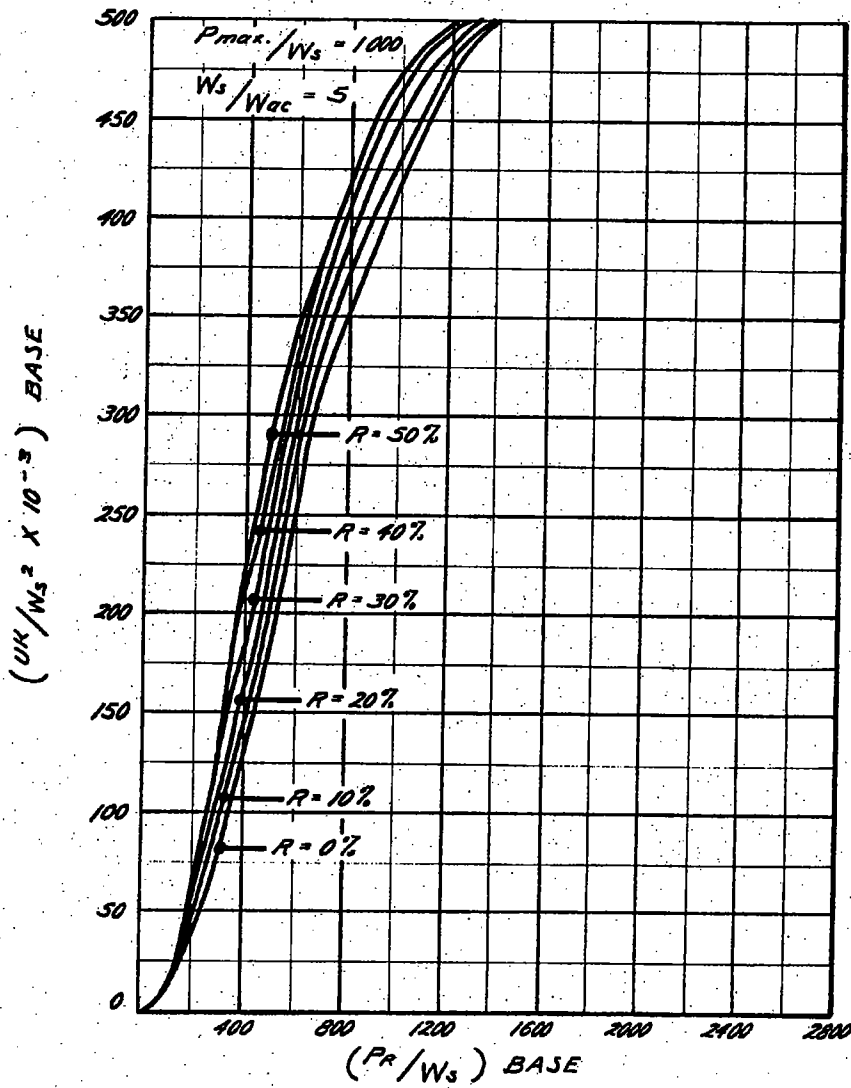

Fig. 29

Jack A. Roll  
Charles H. Samson, Jr.  
Lee L. Lowery, Jr.  
James C. Anderson

INVENTORS

BY James F. Wailer  
Jefferson D. Gilley  
William C. Stout  
Paul L. DeWester Jr.  
Dudley R. Dobie Jr.

ATTORNEYS

Nov. 19, 1968

J. A. ROLL ET AL

3,411,591

COIL POWER SPRING IMPACT MECHANISM

Filed March 3, 1966

28 Sheets-Sheet 17

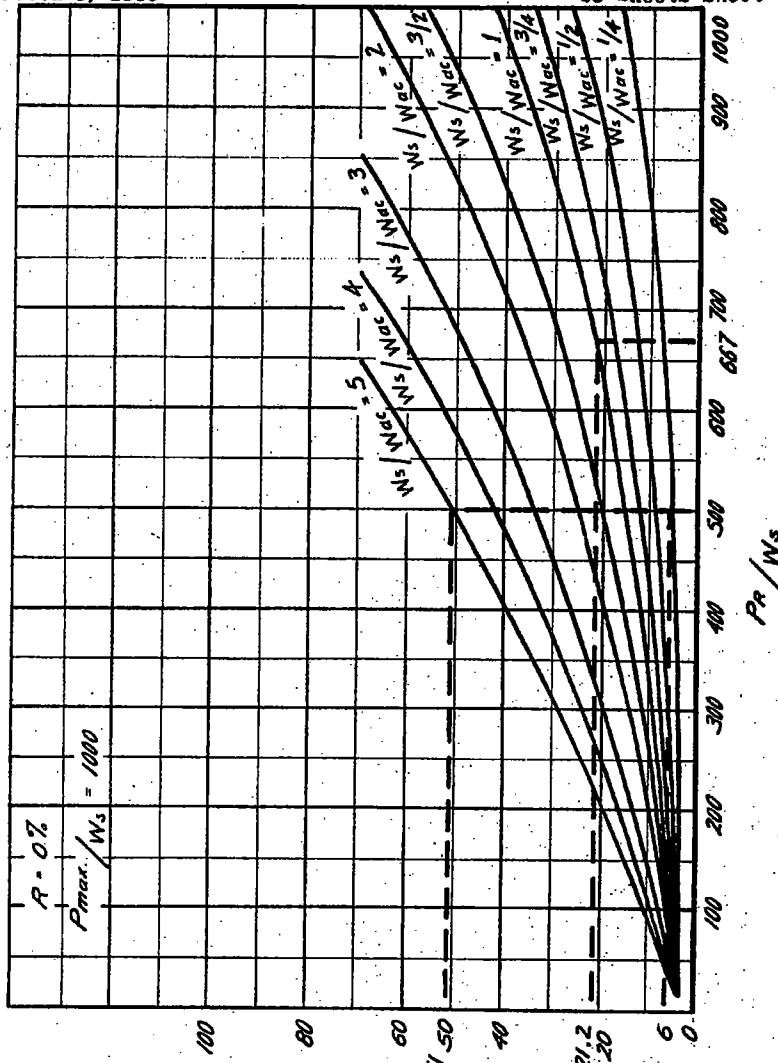

CONVENTIONAL U

*Fig. 30*

Jack A. Roll  
Charles H. Samson, Jr.  
Lee L. Lowery, Jr.  
James C. Anderson

INVENTORS

BY *James F. Wiley*  
*William D. Gilfo*  
*William C. Hoyt*  
*Paul L. DePorter Jr.*  
*Dudley R. Dobson Jr.*  
ATTORNEYS

Nov. 19, 1968

J. A. ROLL ET AL

3,411,591

COIL POWER SPRING IMPACT MECHANISM

Filed March 3, 1966

28 Sheets-Sheet 18

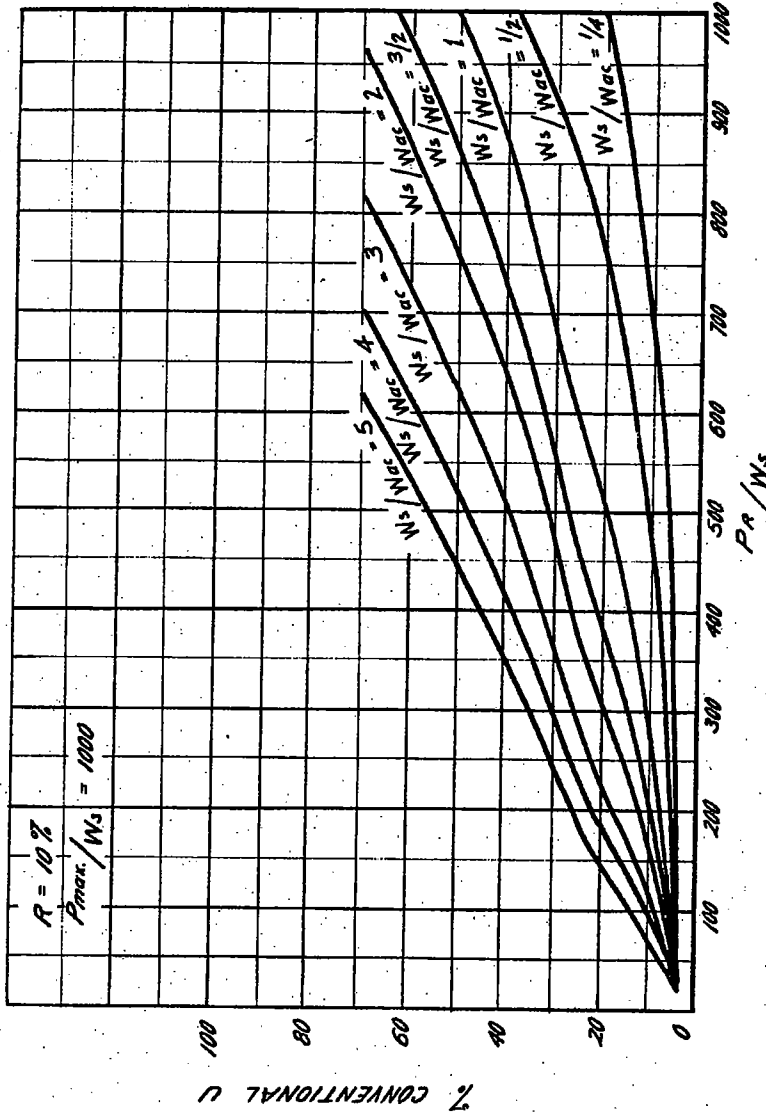

*Fig. 31*

Jack A. Roll  
Charles H. Samson, Jr.  
Lee L. Lowery, Jr.  
James C. Anderson

INVENTORS

BY *James F. Weiler*  
*Jefferson D. Gilley*  
*William G. Stout*  
*Paul J. DeKorty II*  
*Dudley R. Dolbe Jr.*  
ATTORNEYS

